

# RECEPTION GLASS



Products in conformity with UNI laws



European standards accomplishment



Low formaldehyde emission



# FINISHES

## WORKTOPS

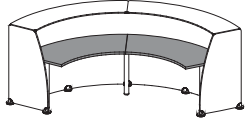

**WE - WENGÉ**



**RR - OAK**



**BA - WHITE**

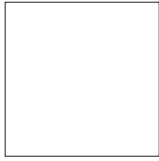

## COUNTERS AND SIDE PANELS

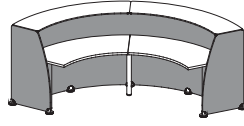

**WE - WENGÉ**



**RR - OAK**



**BA - WHITE**



## TOPS

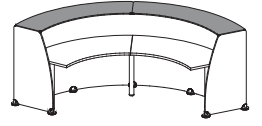

**H - GLASS - MATT WHITE**

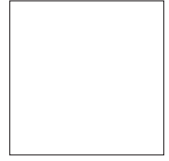

## ROUND LEG, METAL STRIPES, COUNTER BEAMS, BRACKETS

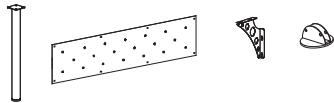

**A - SILVER RAL 9006**



**I - GLOSSY WHITE RAL 9016**



## ADHESIVE STRIPES



**C - CHROME**



# SPECIFICATION SHEET

## COUNTERS

### TOP:

- 12mm thick tempered matt white glass with smooth polished edges and 1,5mm thick bevel;

**SIDES AND BOTTOM:** 18mm thick matt, scratch resistant, non-reflective and washable melamine particleboard (Mfc) with 2mm straight anti- shock ABS edges matching with the top; levelling feet.

**CORNERS:** 18mm thick laminate panels, 0,8mm thick coating (washable, scratch resistant and non-reflective); levelling feet.

### DESKTOPS

30mm thick matt, scratch resistant, non-reflective and washable melamine particleboard (Mfc) with 2mm straight anti-shock ABS edges; Ø 60mm cutout with ABS grommets for cable management; legs: Ø 60mm cylinders in epoxy painted metal sheet; levelling feet.

**ACCESSORIES AND SUPPORTING PARTS:** epoxy painted steel.

# EXAMPLES OF CONFIGURATIONS

- 1 - REBV060 - 60° counter
- 2 - REBV090 - 90° counter
- 3 - REBV100 - straight counters
- 4 - REFC001 - side panels
- 5 - REST151 - 60° concave top
- 6 - REST211 - 60° convex top
- 7 - REST201 - 90° convex top
- 8 - REST091 - 90° concave top
- 9 - REST101 - straight top
- 10 - REGA001 - round leg
- 11 - RESU001 - linking kit and connection
- 12 - RESU003 - square brackets

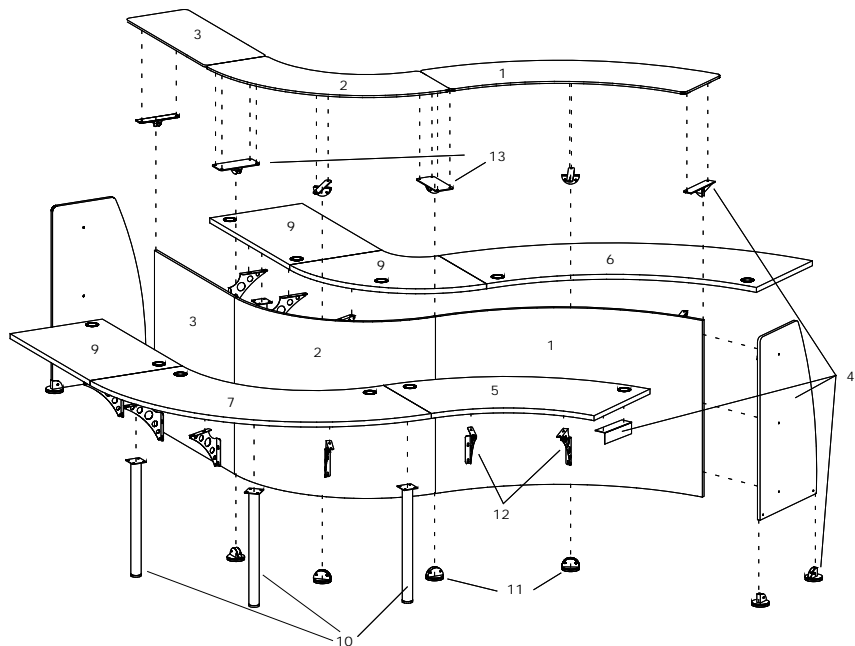

- 1 - REBM093 - low concave 90° reception desk
- 2 - REBM102 - low straight reception desk
- 3 - REBV090 - 90° reception desk
- 4 - REBV100 - straight reception desk
- 5 - REST201 - 90° convex top
- 6 - REST101 - straight top
- 7 - REFC016 - low left side panel
- 8 - RESU020 - linking kit for low counters
- 9 - REFC014 - intermediate side panel
- 10 - REGA001 - round leg
- 11 - RESU001 - linking kit and connection
- 12 - RESU003 - square brackets
- 13 - REFC012 - high right side panel

